



Ventilador Axial - Exaustor

YWF 2S-250S-5DI



Imagem Ilustrativa



Código	73.100.001
Tensão V	220
Rede	Monofásico
Frequência Hz	50 / 60
Rotação rpm	2.650

Modelo	YWF 2S-250S-5DI
Volume Ar m³/h em 60 Hz	1.400
Potência W	130
Corrente A	0,59
Capacitor µF x VAC	3 / 450

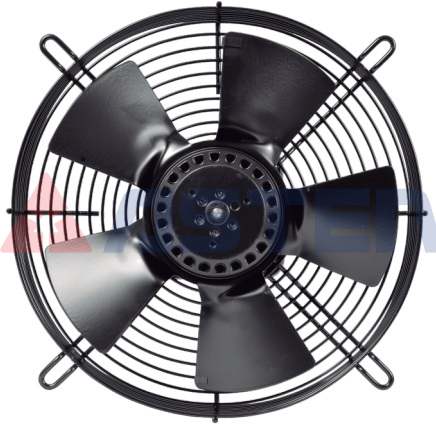
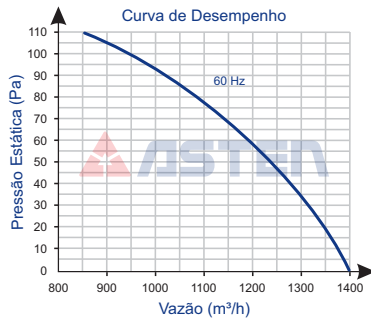
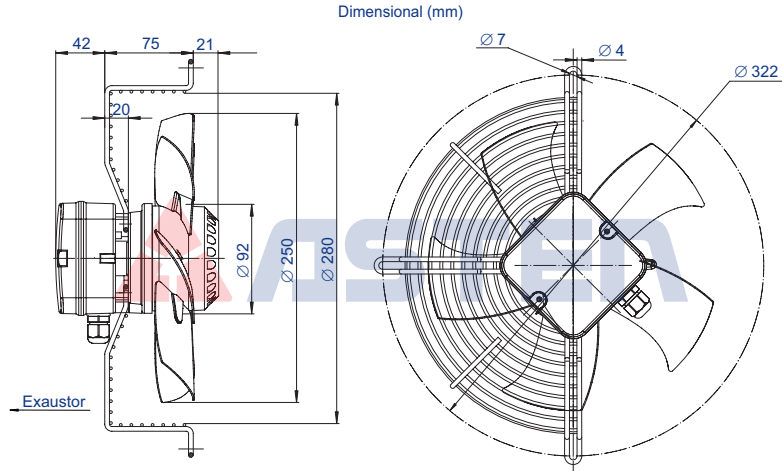
Diâmetro da Hélice	250
Pressão Sonora dB (a)	61
Peso kg	3,0

Ambiente de Trabalho:
-30°C a +60°C