



Ventilador Axial - Soprador

YWF 6T-630B-5DI



Imagem Ilustrativa

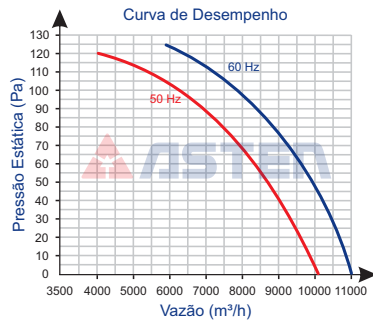
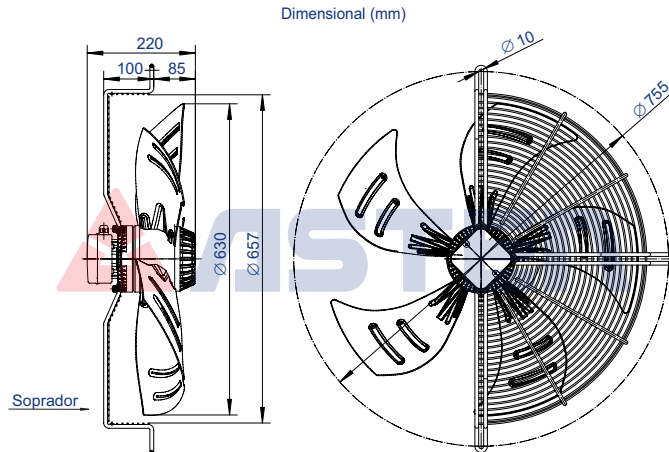

Código	73.100.130
Tensão V	220 / 380
Rede	Trifásico
Frequência Hz	50 / 60
Rotação rpm	1.060

Modelo	YWF 6T-630B-5DI
Volume Ar m³/h em 60 Hz	11.000
Potência W	740
Corrente A	2,60 / 1,56
Capacitor µF x VAC	-

Diâmetro da Hélice	630
Pressão Sonora dB (a)	70
Peso kg	15,4

Ambiente de Trabalho:  
-30°C a +60°C