



Ventilador Axial - Exaustor

YWF 4S-400S-5F11



Imagem Ilustrativa

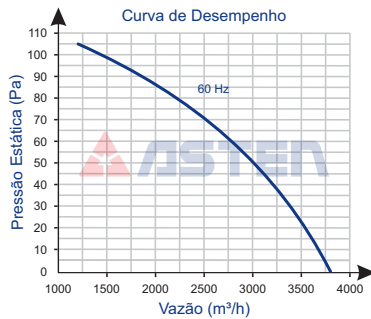
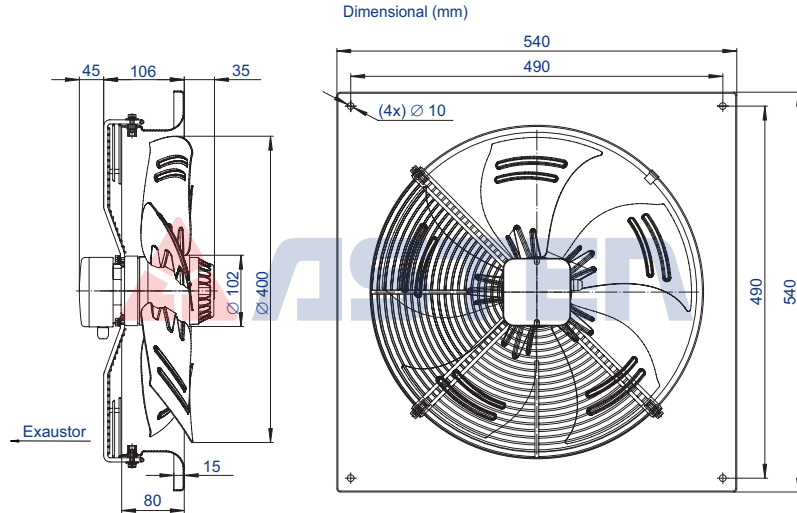

Código	73.100.133
Tensão V	220
Rede	Monofásico
Frequência Hz	50 / 60
Rotação rpm	1.580

Modelo	YWF 4S-400S-5F11
Volume Ar m³/h em 60 Hz	3.800
Potência W	270
Corrente A	1,22
Capacitor µF x VAC	6 / 450

Diâmetro da Hélice	400
Pressão Sonora dB (a)	62
Peso kg	8,5

Ambiente de Trabalho:
-30°C a +60°C