



# Compressor Radial

# CRC - 2 320 26 TD HE

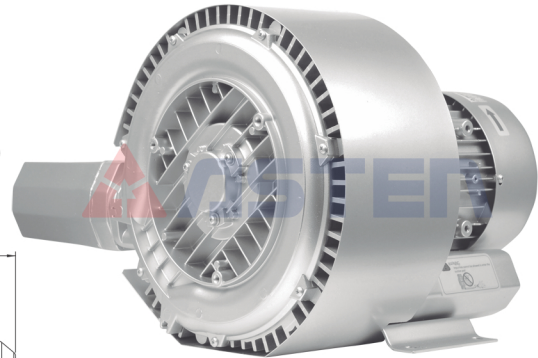

Imagem Ilustrativa

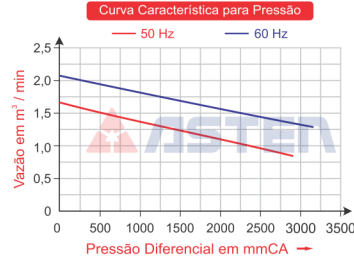
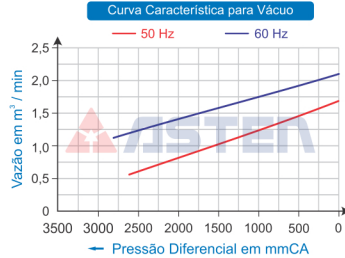
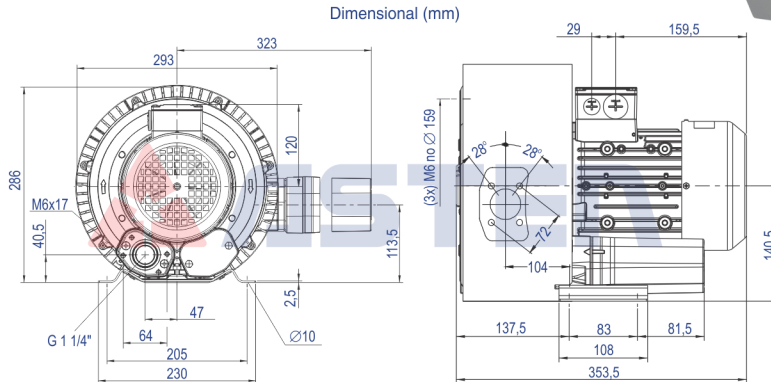

Código	Modelo	Tipo	MOTOR ELÉTRICO						Vácuo Máximo mmCA	Pressão Máxima mmCA	Vazão m³/min	Pressão Sonora dB(a)	Peso Líquido Kg
			Potência	Potência	Rede	Tensão	Frequência	Corrente					
			kW	cv		Volts	Hz	Ampères					
68.200.036	CRC - 2 320 26 TD HE	Duplo Estágio	1,30	1,74	Trifásico	220-290D 380-500Y	50 / 60	4,5 / 2,6	2.800	3.200	2,16	69	27,0