



Compressor Radial

CRC - 2 830 26 TS HE



Imagem Ilustrativa

Dimensional (mm)

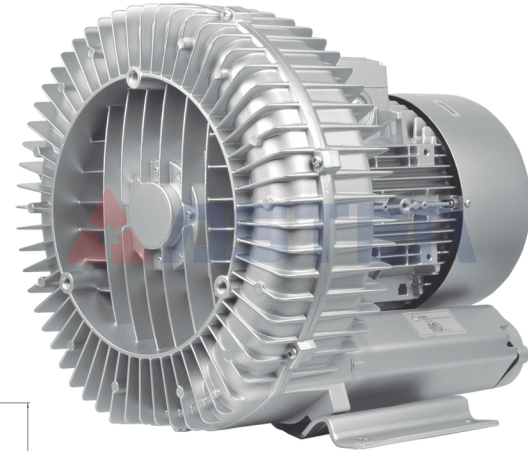
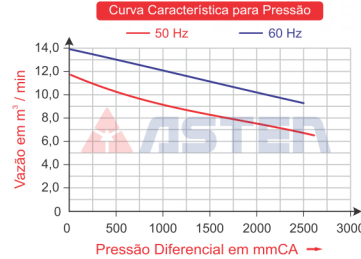
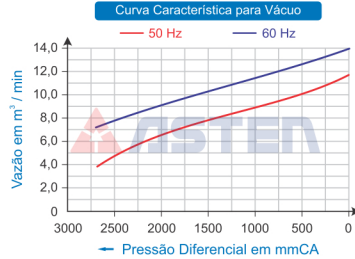
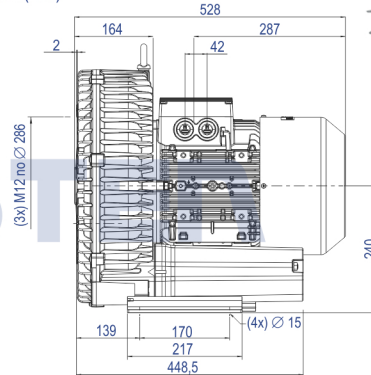
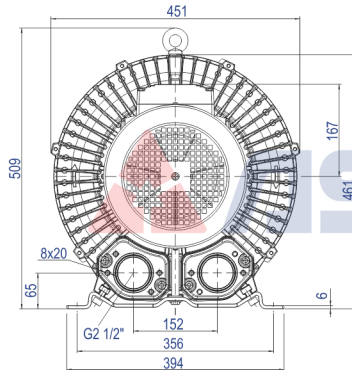

Código	Modelo	Tipo	MOTOR ELÉTRICO						Vácuo Máximo mmCA	Pressão Máxima mmCA	Vazão m³/min	Pressão Sonora dB(a)	Peso Líquido Kg
			Potência	Potência	Rede	Tensão	Frequência	Corrente					
			kW	cv		Volts	Hz	Ampères					
68.200.049	CRC - 2 830 26 TS HE	Mono Estágio	8,60	11,53	Trifásico	220-290D 380-500Y	50 / 60	26,2 / 15,1	2.700	2.500	14,00	74	78,7