



Compressor Radial

CRC - 2 410 25 SS

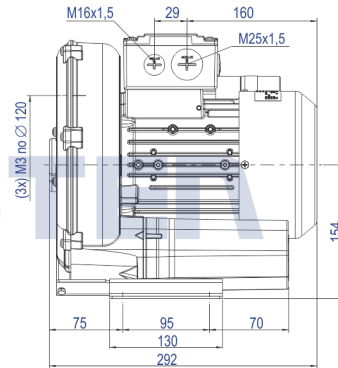
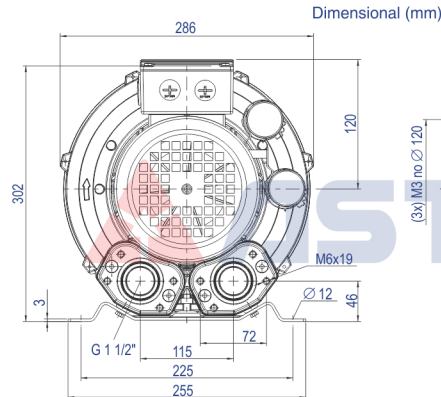
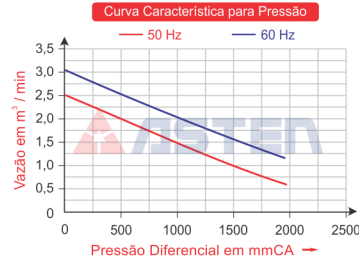
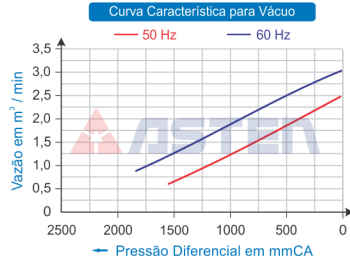

Imagem Ilustrativa

Código	Modelo	Tipo	MOTOR ELÉTRICO						Vácuo Máximo mmCA	Pressão Máxima mmCA	Vazão m³/min	Pressão Sonora dB(a)	Peso Líquido Kg
			Potência	Potência	Rede	Tensão	Frequência	Corrente					
			kW	cv		Volts	Hz	Ampères					
68.200.053	CRC - 2 410 25 SS	Mono Estágio	1,30	1,74	Monofásico	127 / 230	50 / 60	16,6 / 8,3	1.800	1.900	3,15	64	16,0