



Ventilador Siroco Aberto

YWFF 2S-133



Imagem Ilustrativa

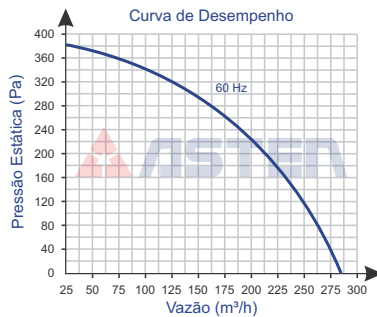
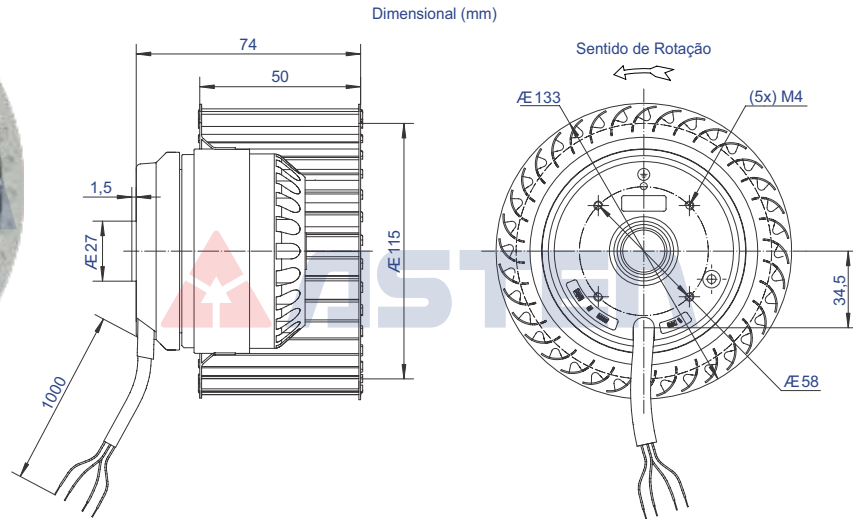

Código	73.100.072
Tensão V	220
Rede	Monofásico
Frequência Hz	60
Rotação rpm	2.990

Modelo	YWFF 2S-133
Volume Ar m³/h em 60 Hz	285
Potência W	85
Corrente A	0,52
Capacitor rnf x VAC	3 / 450

Diâmetro da Hélice	133
Pressão Sonora dB (a)	65
Peso kg	2,3

Ambiente de Trabalho:
-30°C a +60°C